

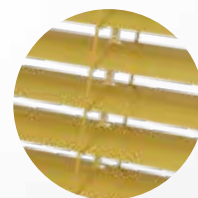

INTERIOR BLINDS

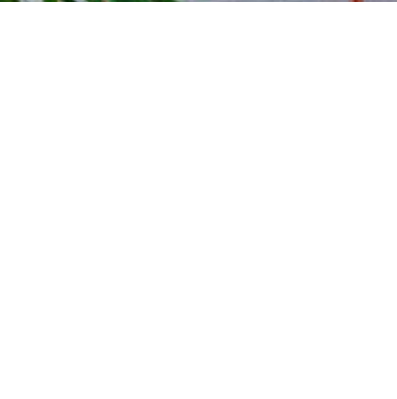

... protect your privacy.

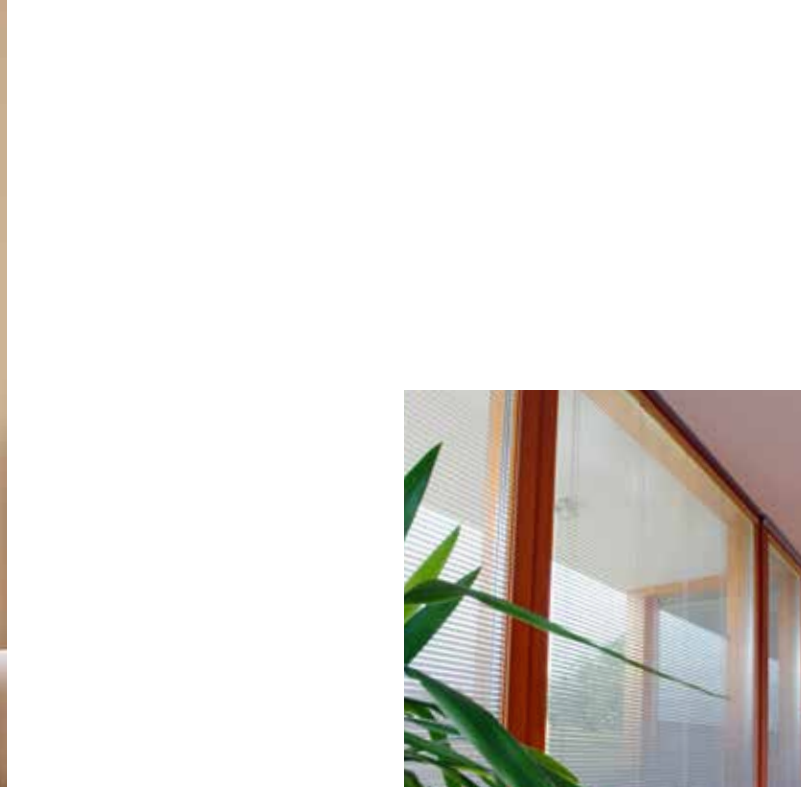

INTERIOR BLINDS

The most common form of shading for rooms is horizontal window blinds. All blinds in this category are aluminium. Aluminium horizontal grids for windows differ in the product series by lamellas, manner of fixation and control and construction of the upper profile. We offer horizontal blinds in a wide range to be able to complete your interior.

ADVANTAGES AND BENEFITS

ELEGANT AND DECORATIVE ELEMENT FOR SHADING OF A MODERN INTERIOR,

EVERLASTING DESIGN,







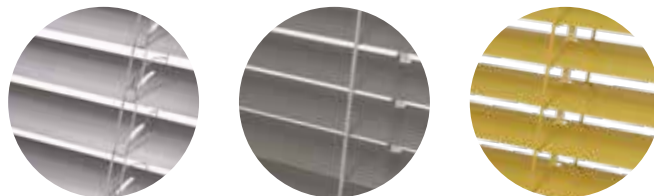





A WIDE RANGE OF COLORS,

OPTIONAL MANUAL OR ELECTRICAL CONTROL,

DAYLIGHT INTENSITY REGULATION.



LEGEND

- | | | | |
|--|---|--|--|
|  Cord |  Button |  Switch |  Tahoma |
|  Cord/Rod |  Wheel |  Remote control | |
|  Ball-chain |  Plastic handle |  Strap | |
|  Handle |  Sun/wind sensor |  Control bar | |

ISOTRA *Quality*

A brand symbolizing years of tradition, innumerable investments into research and development, use of high-quality materials, technological advancement, reliable work of hundreds of employees and many more parameters, which together form one whole - the final product of the company ISOTRA.



SYSTEM CLASSIC, HIT, HIT II

... protect your privacy.

The warming light, cooling shade and everything between is offered by the ISOTRA System Classic interior shading.

The uncluttered design, functionality and high-quality aluminium construction are the basic characteristics of this much sought after blind. The ISOTRA System Classic interior shading is the optimal solution for traditional and non-standard windows.

Compared with the ISOTRA System Hit and HIT II interior shading, the ISOTRA System Classic has an aluminium lower and upper profile that ensures greater strength and a longer service life. Therefore, it is recommended as the blind for EURO windows, as well as for other plastic and aluminium window types.

If looking for optimal price and quality, the ISOTRA HIT system interior shading is the best option. With the simple upper profile design, ISOTRA HIT system blinds perfectly shade interiors. The price of the blind is low, on the contrary, the functionality is very high: 100%.

Timeless design, precise construction of individual lamellas and easy control – these are the features of the high-quality ISOTRA HIT II blind system.

The extraordinary character of the interior shading is based on the construction of the upper profile. This solution will ensure the minimum penetration of light between the first lamella and the profile. The ISOTRA HIT II blind system is a practical aid that allows as much light through as you need. If you wish, we can cover the upper profile, lower profile and lamellas in proportionate wood imitation.

MIN. WIDTH [mm]	MAX. WIDTH [mm]	MAX. HEIGHT [mm]	MAX. SURFACE GUARANTEED [m ²]
300	2000	2200	2,5



Advantages and benefits of the ISOTRA System Classic

- Profiles from extruded aluminium - recommended as the blind for EURO windows,
- non-standard version for bevel and broken windows,
- colour constructions of the profile according to the RAL pattern.

Control



Installation options

- For window wing,
- the blind can be fitted with a brake to prevent falling of lamellas due to their own weight.



Advantages and benefits of the ISOTRA HIT blind system

- Optimal quality-price ratio,
- simple upper profile design,
- low control force,
- colour constructions of the profile according to the RAL pattern.

Control



Installation options

- For window wing,
- the blind can be fitted with a brake to prevent falling of lamellas due to their own weight.



Advantages and benefits of the ISOTRA system HIT II

- Timeless design,
- minimum penetration of light between the first lamella and the upper profile,
- greater rigidity of the upper profile low control force,
- low control force,
- colour of the profile according to the RAL sampler or coated in renolite with imitation wood,
- high-quality blinds as a result of the manufacturing procedure.

Control



Installation options

- For window wing,
- the blind can be fitted with a brake to prevent falling of lamellas due to their own weight.



INTERIOR SHADINGS ISOLITE, ISOLITE PLUS, NEOISOLITE

... protect your privacy.

The charm of your interior will be completed by an Isolite interior shading that combines the modern design of the upper profile and the precise construction of each lamella.

This perfection is also supported by harmonization of the upper profile, lower profile and lamella with wood imitation.

The Isolite plus interior shading lets you flirt with the sun. The elegance of the round upper profile of the Isolite plus interior shading combined with the perfectly shaped lamellas attracts demanding clients and experts in light and shade.

With the easy use and good shading abilities of the Isolite plus blind, the amount of light you allow into the interior is solely up to you. In the case of the Isolite plus blind, the upper profile, lower profile and lamellas can be harmonized using wood imitation.

Neoisolite aluminium blinds combine simple elegance with an industrial purpose. The option to tilt out blinds from the window wing enables the whole window to be cleaned. The sophisticated design of the Neoisolite blind is highly appreciated by both men and women.

The precise construction and palette of various shades offers unlimited options for interiors in terms of style and colour and to give it just the right atmosphere. In the case of the Neoisolite blind, the upper and the lower profile and the lamellas can be harmonized with wood imitation.

TYPE	CONTROL	MIN. WIDTH [mm]	MAX. WIDTH [mm]	MAX. HEIGHT [mm]	MAX. SURFACE GUARANTEED [m ²]
Isolite	chain	300	2000	2200	4,4
Isolite	engine	400	2000	2200	4,4
Isolite plus	chain	300	2000	2200	4,4
Isolite plus	engine	400	2000	2200	4,4
Neoisolite	chain	400	2000	2200	2,5



Advantages and benefits of the Isolite window blind

- Modern design,
- profiles from extruded aluminium,
- non-standard version for bevel and broken windows,
- colour of the profile according to the RAL sampler or coated in renolite electric control option,
- electric control option,
- planetary gear for easy control of above-dimensional blinds.

Control



Installation options

- For window wing,
- the blind can be fitted with a brake to prevent falling of lamellas due to their own weight.



Advantages and benefits of the Isolite Plus

- Elegant design,
- profiles from extruded aluminium,
- non-standard version for bevel and broken windows,
- colour of the profile according to the RAL sampler or coated in renolite,
- electric control option,
- planetary gear for easy control of above-dimensional blinds,
- recommended for blinds for plastic windows.

Control



Installation options

- For window wing,
- the blind can be fitted with a brake to prevent falling of lamellas due to their own weight.



Advantages and benefits of the Neoisolite aluminium blind

- Elegant design,
- assembly using corner clamps,
- option to tilt out the blind for easier window washing,
- profiles from extruded aluminium,
- colour of the profile according to the RAL sampler or coated in renolite.

Control



Installation options

- For window wing,



VARIABLE WINDOW BLINDS SYSTEM 25

... protect your privacy.

The variable System 25 window blinds can be fully adapted to your requirements. The unique system offers four control options, a wide range of colours and a sophisticated functional design. Select the colour shade of the lamellas and from one of 15 available colours for the upper cover profile! (It is possible to coordinate everything with wood imitation). The rounded cover profile compared with Isolite plus blinds is optional, therefore, the blind can be selected with or without the upper cover profile.

The System 25 interior window blind is also available in non-standard versions – to fulfil your wishes and requirements.

CONTROL	MIN. WIDTH [mm]	MAX. WIDTH [mm]	MAX. HEIGHT [mm]	MAX. SURFACE GUARANTEED [m ²]
cord, chain	300	2 000	2 200	2,5
handle	400	2 000	2 200	2,5
engine textile tape, System 25 Large	400	2 000	2 200	4,4
engine cord	600	2 000	2 200	4,4

The atypical version is produced only in SYSTEM 25S, 25SM and 25SW.

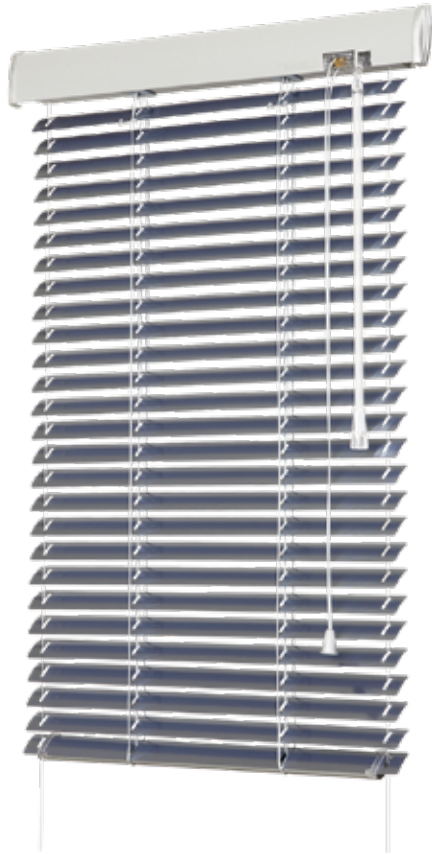

Advantages and benefits of the System 25 window blind system

- Construction with and without upper profile cover,
- variable system for opening – cord, chain, level, engine,
- non-typical variant for bevel and broken windows,
- in between glass panes option,
- colour of the profile according to the RAL sampler or coated in renolite.

Control



Technical parameters

System 25 is a blind that comes in two different constructions (with or without the covered profile) and four different control options. It has a unique and versatile installation.

System 25 blinds – construction with covered profile



Installation options

- For window hole (ceiling) – only the version without the covering profile,
- in front of the window hole (wall) – for version with the cover profile,
- for window frame.

System 25 blinds – construction without covered profile





WIRELESS ELECTRIC BLINDS FOR CONTROL ISOTRA ENERGY

... protect your privacy.

This revolutionary new product using electronic shading technology is the ISOTRA Energy solar blind, which operates using solar energy. If you are looking for a unique, fully automated blind which is wireless-controlled and uses zero electricity then the ISOTRA Energy electric blind is designed especially for you.

The blind functions on the photovoltaic effect principle - i.e. conversion of solar radiation to electricity. ISOTRA Energy solar blinds represent synergy of design, practicality, utility and energy savings. Minimum effort - maximum effect.

MIN. WIDTH [mm]	MAX. WIDTH [mm]	MAX. HEIGHT [mm]	MAX. SURFACE GUARANTEED [m ²]
400	2000	2200	2,5

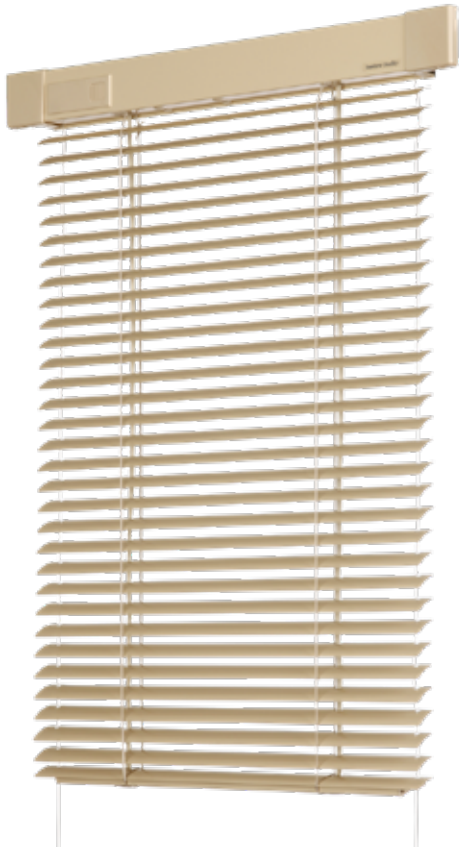

Advantages and benefits of the ISOTRA Energy solar blind

- Electric blind using solar energy for operation,
- zero electricity consumption,
- fully automated wireless control,
- colour constructions of the profile according to the RAL pattern.

Control



Installation options

- For window wing.





INTERIOR BLINDS

CETTA 35, 50 - ECONOMY, CETTA 35

... protect your privacy.

Cetta Economy represents the economic version of the interior blind with lamellas with widths of 35 mm or 50 mm. They are recommended for interior use in flats, manufacturing halls, administrative buildings and large premises where the emphasis is on functionality and aesthetics. The lamellas are in the form of the letter "C", and are without folders at the ends. The lamellas for the blinds are located in the steel rope or a freely hanging blind without guiding can be selected.

Easy control, uncompromising functionality and a competitive price - this is Cetta Economy.

Cetta 35 blinds are designed for interior use. Lamellas with a width of 3.5 cm are in the form of the letter "C", without folders at the end of the lamellas. The blind lamellas have steel wire guides.

The Cetta 35 and Cetta 50 lightened blinds are recommended for installation in places not affected by strong winds. Cetta 35 blinds cannot be mounted into Heluz heads. The Cetta 35 is specifically designed for administrative buildings.

TYPE	CONTROL	MIN. WIDTH [mm]	MAX. WIDTH [mm]	MAX. HEIGHT [mm]	MAX. SURFACE GUARANTEED [m ²]
Cetta 35, 50 Economy	cord	400	3150	3000	6,0
Cetta 35	cord	400	3 500	3000	6,0
Cetta 35	wheel	400	3 500	3000	8,0
Cetta 35	motor	600	3 500	3000	10,0



Advantages and benefits of CETTA 35, 50 - ECONOMY

- Economic version of the construction,
- two widths of lamellas: 35 mm and 50 mm,
- simple cord control with brake,
- double sided tilting of lamellas,
- guiding by rope or freely hanging blinds,
- arbitrary regulation of intensity of the light,
- easy assembly into the ceiling or on the wall.

Control



Installation options

- Into the ceiling,
- on the wall.

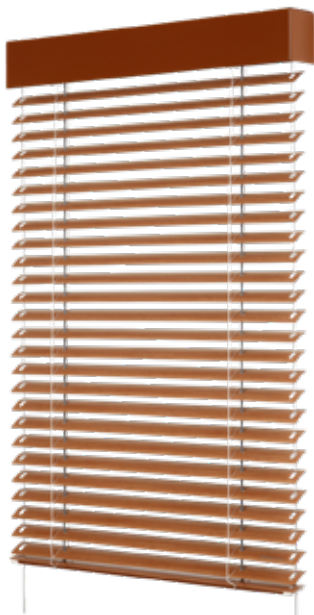

Advantages and benefits of CETTA 35

- Especially recommended for interiors,
- lamella colour alternatives are also available in imitation of wood,
- electric control option,
- guaranteed area of up to 10 m².

Control



Installation options

- Installation into created pocket (ceiling / wall),
- installation into reveal on the window frame (ceiling / wall),
- installation on expanding window profile (ceiling / wall).

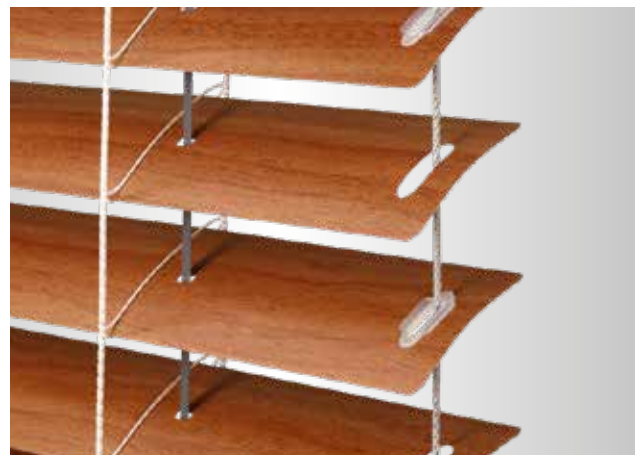



INTERIOR ROOF BLIND V-LITE

... protect your privacy.

V-Lite roof blinds are interior shadings manufactured for all types of roof windows. A high-quality construction with aluminium leading bars combined with a suitably selected fabric ensures the fluent regulation of light. According to the window position in which the blind is located, you can choose between two methods of control.

Even if the window is located in a high position, you can easily manipulate the roof blind using the control on the leading bar together with the control rod.

MIN. WIDTH [mm]	MAX. WIDTH [mm]	MAX. HEIGHT [mm]	MAX. SURFACE GUARANTEED [m ²]
300	1200	1600	1,5



Advantages and benefits of the V-Lite blind

- For all types of roof windows,
- leading bars prevent light penetrating the sides of the window,
- profiles and leading bars from satin anodized aluminium or in white color (RAL 9003),
- easy control using the bar for difficult-to-access windows.

Control



Installation options

- For window wing.





CHILD SAFETY

Children are the most important part of our lives. We love to watch their progress, we take pleasure in their new skills, we rejoice at their curiosity and how they discover the world that

surrounds them. But ordinary home accessories, appliances, furniture as well as blinds and roller blinds can be potentially dangerous for infants and small children.

The ISOTRA blinds and roller blinds represent a top-level technical solution meeting the requirements for modern design. As a matter of course, the company intends to fulfill specifications of the EN 13120 standard for child safety, and therefore ISOTRA has developed the following proprietary protective elements:

CONNECTION

The connection ensures that the chain breaks apart when load exceeding 6 kg is applied, thus eliminating the dangerous loop.

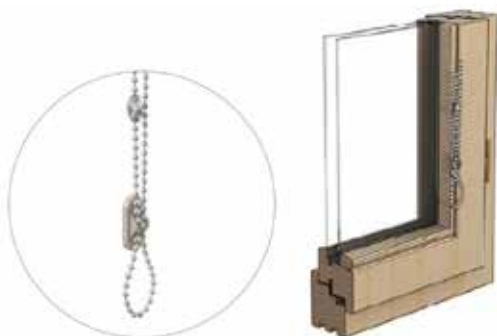

PULLEY

The pulley tensions the pull cords in a way preventing the formation of a dangerous loop.

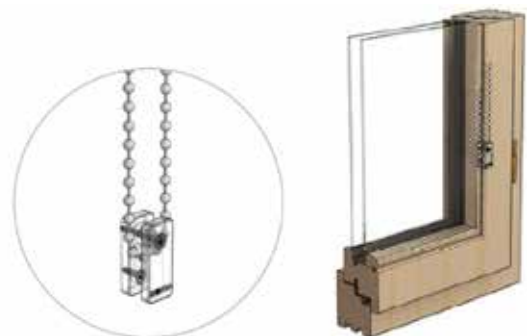

REEL, TWO WHEELS

Prevent the cords from forming a loop, while keeping them out of the reach of children.



All of our interior shading products are equipped with warning labels, attached to the products as well as their packaging.

Table of ISOTRA protective elements

INTERIOR SHADING	Safe type of operation						Dangerous operation			Suitability of ISOTRA protective systems			
	Manually	Wheel	Handle	Switch	Remote control	Control bar	Cord	Cord / Rod	Ball-chain	Coupler	Pulley	Reel	Two wheels
ISOTRA SYSTEM HIT									✓	✓			
ISOTRA SYSTEM HIT II									✓	✓			
ISOTRA SYSTEM CLASSIC									✓	✓			
ISOTRA ENERGY					✓								
ISOLITE				✓	✓				✓	✓	✓		
ISOLITE PLUS				✓	✓				✓	✓	✓		
NEOISOLITE									✓	✓			
SYSTEM 25S, 25SM								✓					✓
SYSTEM 25R									✓	✓			
SYSTEM 25L (large)									✓		✓		
SYSTEM 25K		✓											
SYSTEM 25SW								✓					✓
SYSTEM 25M				✓	✓								
CETTA 35, 50 - ECONOMY								✓				✓	
CETTA 35		✓		✓	✓			✓				✓	
CETTA 50 (usage in interior)		✓		✓	✓			✓				✓	
V-LITE INTERIOR ROOF BLIND	✓					✓							
ATYPICAL CHAIN BLINDS									✓			✓	
CHAIN BLINDS WITH BRAKE									✓			✓	
CHAIN BLINDS (space > 2,5 m²)									✓			✓	

■ Safe type of operation means that these methods in their current versions fulfil the requirements of the standard. When used, they do not create dangerous loops or pose strangulation hazard.

■ Dangerous operation means that these operating methods can create a loop, i.e. they pose strangulation hazard.

■ The suitability of ISOTRA protective systems shows which protective system is connected to the respective interior shading type in order to eliminate strangulation hazard.

ABOUT US

HISTORY

In 1992, two brothers-in-law, Bohumír Blachut and Erich Stavař, decided to set up their own business in their home village of Bolatice near Opava. They started in a garage, establishing a company they named ISOTRA. ISO came from the word for insulation and TRA from trade, as they were originally involved in the trade and installation of window sealing. Much has changed since then, but the company's identity remains

the same. In 1993, they started dealing in the current product line – window blinds. Always seeking to improve their products, and reacting to the current market demand, they decided, in 1995, to start production of their own blinds and components, with continuous expansion of the shading product line.

DIRECTION OF DEVELOPMENT

What sets ISOTRA apart from its competition is primarily the fact that the company is able to develop a completely new, customised product from A to Z. This comprises designing, manufacture of the individual components, testing and certification of the new product, setting up the technological processes, developing new machinery, and supplying

the complete technology. The company holds patents for a number of things, at high standards of excellence. The technologies, production processes, as well as research and development in solar shading make ISOTRA one of the leading producers of sun-shading products and a technological leader not only in the Czech Republic.

MANUFACTURING PROGRAMME

ISOTRA has its own R&D department, a design office, technologies, a state-of-the-art tool shop, a new powder coating shop, a press shop for thermoplastic materials, and extensive production facilities. The company offers a comprehensive product range, including the product groups of interior and exterior blinds, fabric roller blinds, pleated blinds, Japanese walls, exterior roller blinds, insect screens, awnings, screen roller blinds,

verandas, and ARTOSI bioclimatic pergolas. The production of components, profiling machines, cutting tools, and technological units for the manufacture of the blinds is an inseparable part of the manufacturing programme. Technological maturity of the company is documented by the possession of several worldwide patents and utility models for the technical solutions in the area of shading technology.

ISOTRA QUALITY

Quality, reliability, customer care, research, development, technologies and innovations with respect to energy savings – these are ISOTRA's fundamental values. The company pursues the objective of providing the customers with branded, clearly identifiable, technologically advanced

products of corresponding quality. ISOTRA a. s. holds the certificates of quality in accordance with the Czech standards ČSN EN ISO 9001:2009 and ČSN EN ISO 14001:2005, employs more than 600 employees, and exports its product to more than 46 countries worldwide.

30 YEARS WITH YOU

Thirty years of ISOTRA on both the domestic and international markets is proof of constant growth, innovations, reliability, expertise, and tradition. ISOTRA has remained a solely Czech company that keeps expanding. The establishment of subsidiaries in Germany and Poland is indis-

putable evidence of this fact. The brand is currently being reinforced by expanding the Partner network in the Czech Republic, Slovakia, as well as further abroad. The red background of the ISOTRA logo depicts the dynamics with which ISOTRA has been evolving over the last 30 years.

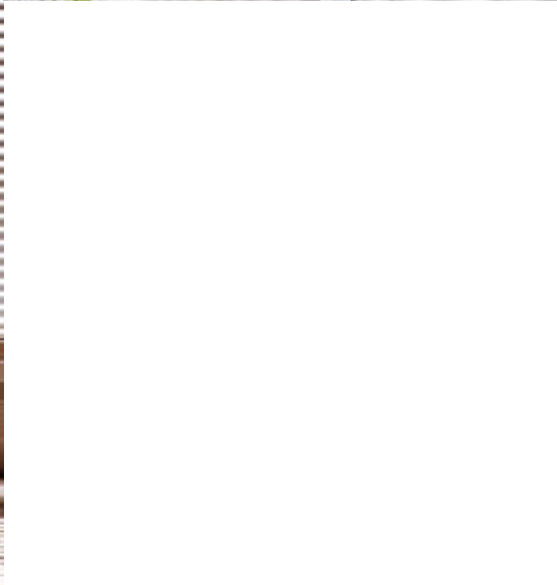
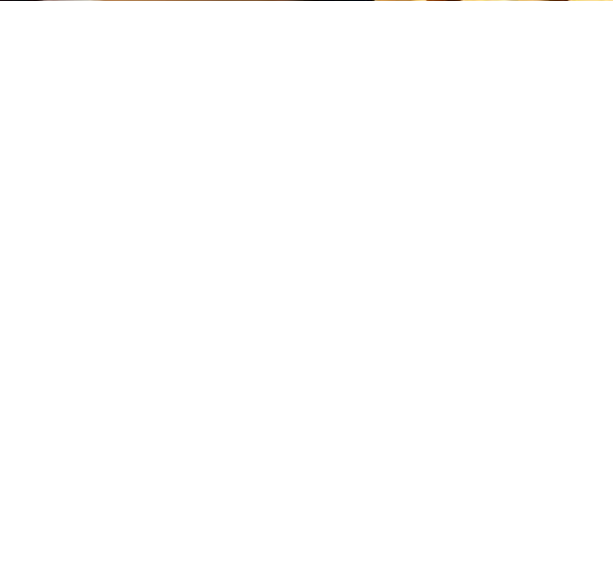



ISOTRA a.s.

Bílavecká 2411/1, 746 01 Opava
Czech Republic

Phone: **+420 553 685 111**
E-mail: isotra@isotra.cz

www.isotra.com

Issue: 04/2020

ISOTRA Partner:



... protect your privacy.